

 **Matsura**

High Grade Linear Motor Machine

LX-160



MAXIA
Innovation by  Matsura

LX-160

Ultimate CNC Performance in High Speed and Accuracy State of the Art Linear Motor Technology

- The cycle time can drastically be shorted thanks to 48% reduction in tool change time and optimal location of the tilting rotation center which is moved closer to the machining point.
- Optimised rigidity assures a stable machining platform.
- Matsuura's proven software:
Intelligent Protection System collision avoidance and next generation operating software **MIMS**.

■ Target Markets

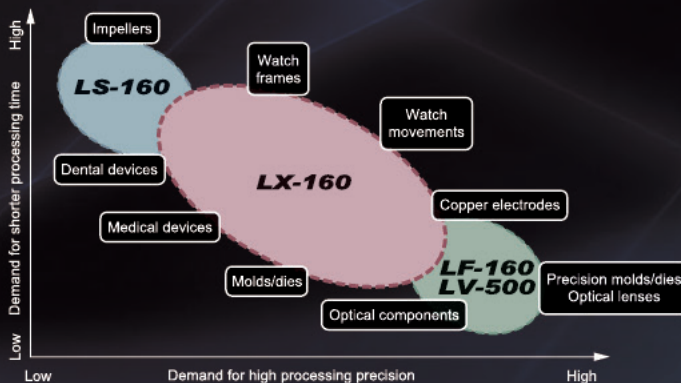

■ Maximum Workpiece Size * Bullet shape (inch)

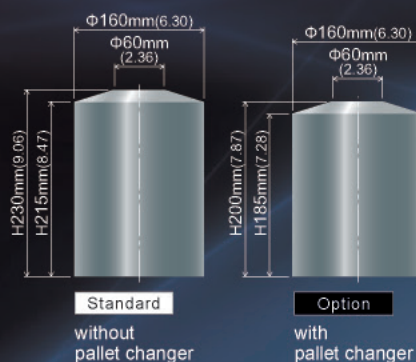

Expanding the boundaries of technology is at the heart of Matsuura. The era of ultra high speed and accuracy linear motor CNC machining began with the Matsuura **LX-1**.

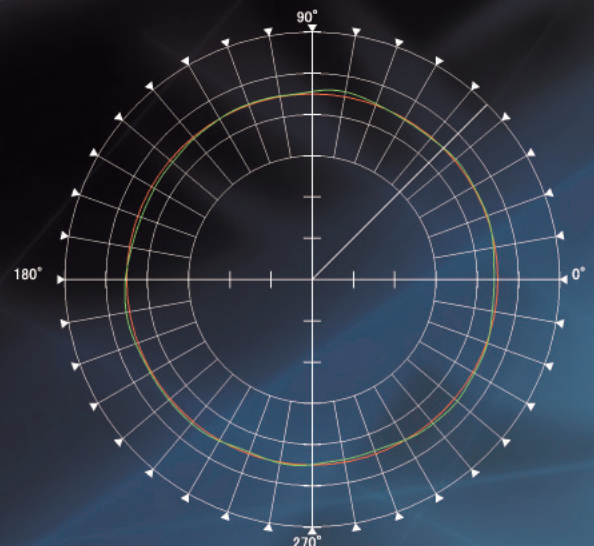

Amazing measurement results prove high precision

Roundness 1μm (actual value)
(0.000039in)



The **LX** Series continued to set the pace with the 3 axes **LX-0** - a small footprint machine offering outstanding performance for small intricate molds and dies.

Scalable and tailored options to the customer's process 

Dedicated to the high-speed, high-accuracy market 



Following on from the success of the LX-0 the 5 axes LX-0 5AX was launched delivering unmatched accuracy and speed to complex geometric components.

The LX-0 5AX built a reputation for excellence in a wide range of machining disciplines and industries - its legacy is the all new 5 axes LX-160.



The LX Series is constantly evolving and offers the ultimate platform in linear motor CNC technology

Dedicated to the high-speed, high-accuracy market — with a focus on small workpiece processing and linear motor drive technology



MAXIA Spindle

- Maximum spindle speed is 46,000min⁻¹.
- Spindle motor output is 7.5/15 kW.
- Spindle motor torque is 8.6 N·m.
- Spindle noise level is 75 dB.

Spindle Taper BT30 Standard

Spindle Taper HSK-E40 Option

- Motor torque has been increased 20% - & the low noise **LX** spindle is further reduced in volume by 10%.

■ Spindle Motor Torque & Power Diagram

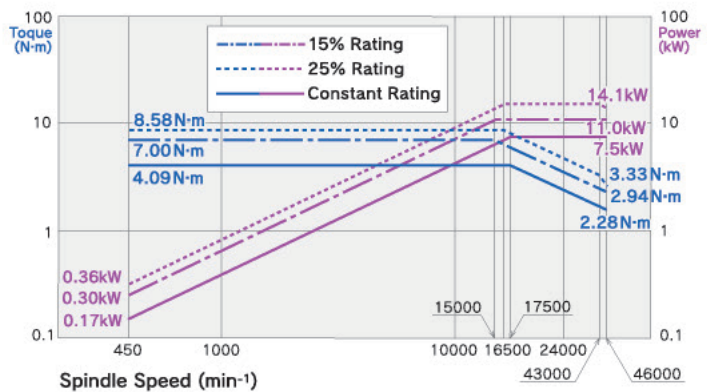

Even faster Steel and Aluminium cutting

■ Cutting Test Data

				(inch)			
				Spindle Speed	Feed rate	Quantity	Spindle load
END MILL 	A5052	Ø16mm (0.62) 2teeth carbide	W=14mm (0.55) D=3mm (0.11)	46,000 min ⁻¹	16,000mm/min (629.92)	672 cc/min	126%
	S45C	Ø16mm (0.62) 4teeth carbide	W=1mm (0.03) D=16mm (0.62)	6,000 min ⁻¹	5,000mm/min (196.85)	80 cc/min	123%
DRILL 	A5052	Ø14.5mm (0.57) HSS		1,300 min ⁻¹	120mm/min (4.72)	19.8 cc/min	93%
	S45C	Ø6.8mm (0.26) HSS		900 min ⁻¹	80mm/min (3.14)	2.9 cc/min	37%
TAP 	A5052	M12 × P1.75 HSS		400 min ⁻¹	700mm/min (27.55)	Solid tap function is used	143%
	S45C	M8 × P1.25 HSS		400 min ⁻¹	500mm/min (19.68)	Solid tap function is used	119%

Note: The data above is from examples of actual results. Depending on conditions, there may be cases where results equivalent to those of the catalog data may not be able to be obtained.

Measurement results proving the high precision

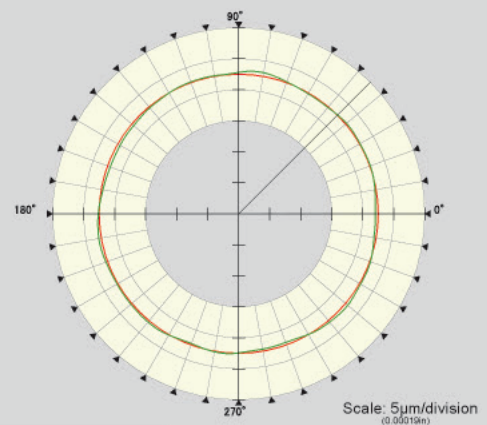

Roundness
1µm
(0.000039in)
(actual value*)

Filter	1-15
Material	Aluminum (A5052)
Spindle speed	30,000min ⁻¹
Feed rate	5,000mm/min(196.85ipm)
Tool	Slot drill

* The actual value is not intended to guarantee the performance.

Control Axes (inch)

- All axes are driven by linear motors to achieve high speed and rapid acceleration/deceleration.

Rapid Traverse Rate

X-Axis 90,000mm/min (354.3ipm)	B-Axis 100min ⁻¹
Y-Axis 90,000mm/min (354.3ipm)	C-Axis 200min ⁻¹
Z-Axis 90,000mm/min (354.3ipm)	

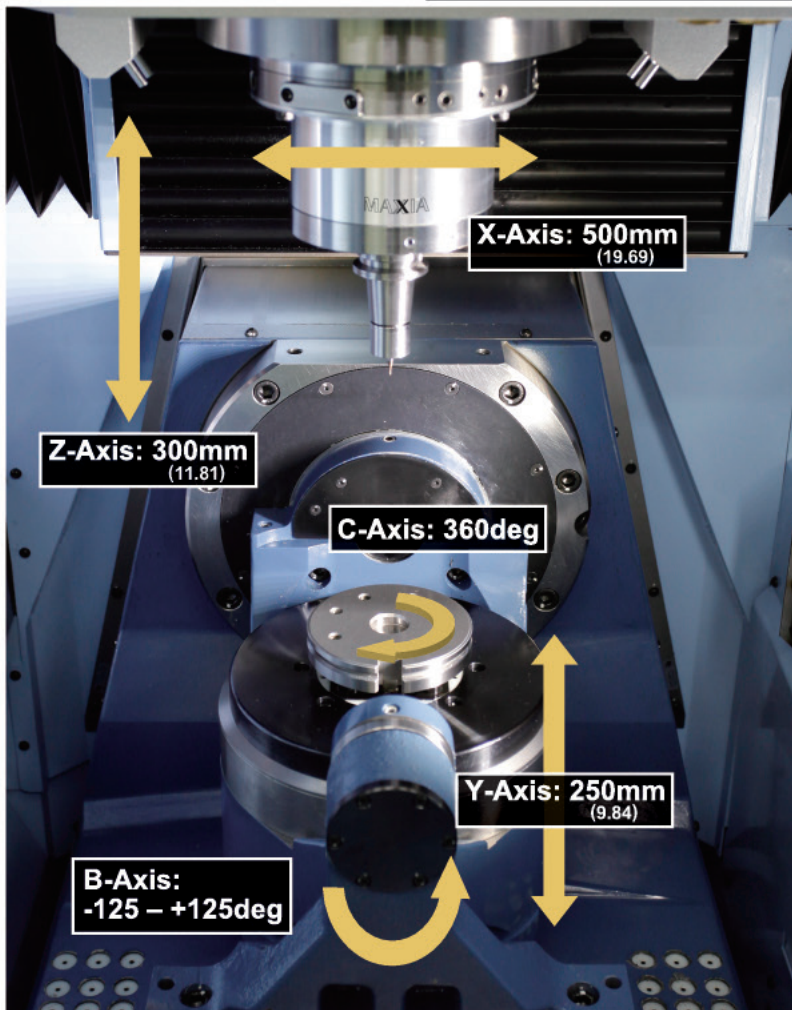

Liner Motor Drive

- Direct drives enable high speed, high accuracy processing.
- With the exception of the guide surface there are no two parts that create friction, vastly reducing mechanical wear and tear. Minimised component design assures reliability.
- High gain characteristics of linear motors enables positive loop gain of more than 10 times that of conventional motors, guaranteeing high accuracy.

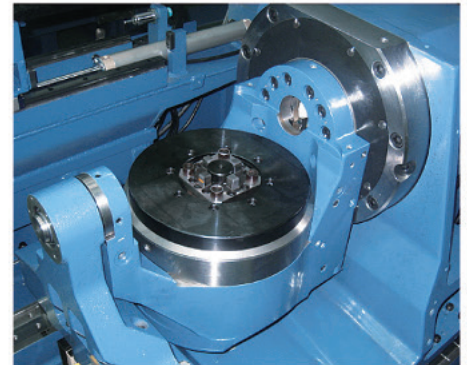

B / C Axis

- The B and C axes are also driven by DD motors.

Rapid Traverse Rate

B-Axis : 100min⁻¹ / C-Axis : 200min⁻¹

Table Rotation Torque

B-Axis : 122N•m / C-Axis : 45N•m

Table Breaking Torque

B-Axis : 230N•m / C-Axis : 60N•m

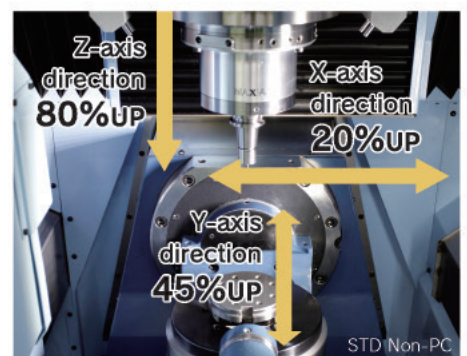

High-rigidity Design

- Optimum rigidity is assured on all Matsuura products via FEM and our established track record for excellence in engineering.
- High rigidity, linear motors and exceptional spindle speeds identify the **LX-160** as a unique solution for high precision high gain machining.

Scalable Options Tailored to Your Process. Designed for Unmanned Production.

Tool magazines

Drum Magazine

Standard



* Even if an additional magazine unit is installed, the machine still has the standard 10-tool drum-type magazine.

Chain Magazine

Option

• The standard 10-tool magazine can be extended to a 30-tool magazine with the addition of a 20-tool chain-type magazine (10 + 20 = 30), and 50 with the addition of a 40-tool magazine (10 + 40 = 50).

30/50Tool Chain Magazine

Option

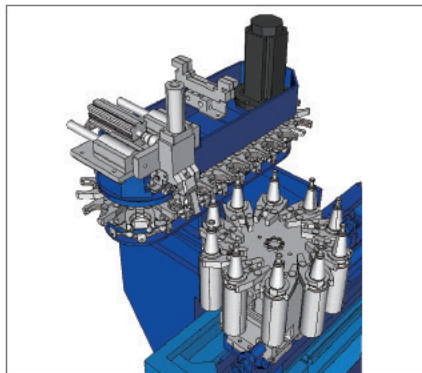

Matrix Magazine

Option

• Up to 338 tools can be set at a time.
(128 / 188 / 248 / 308 / 338 tools)

128 – 338Tool Matrix Magazine

Option



Pallet magazine

PC is integrated design for compact space.

PC2

W-grip type

Option



PC2



PC2

Pallet is Matsuura made.
Pallet clamping device can be selected from "system 3R" and "EROWA".

system 3R the Pioneer

EROWA® 

PC42

PC91

Linear pallet systems PC42 and PC91 are included in the lineup.



PC91



Ergonomic Design

(inch)

The front guard is designed with comfort in mind, providing a space for the operators' feet allowing close positioning to the machine.

- The NC can be slid and revolved for maximum operator comfort and control.

Easy access maintenance at the rear of the machine.

- Opening width of the operator door is 580mm (22.83), offering superb unfettered access to the machining enclosure.

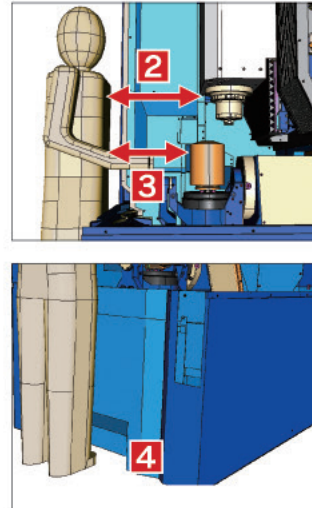
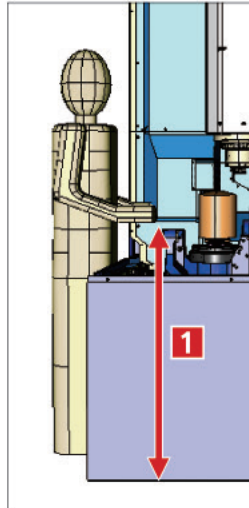

- 1** Floor – workpiece mounting surface
900 mm (35.43) : without PC
930 mm (36.61) : with PC
- 2** Guard front – spindle center
550 mm (21.65)
- 3** Guard front – workpiece center
450 mm (17.72) : closest approach
- 4** Foot Cavity in Front Guard
Ergonomically designed for easier approach and operator comfort.

Swarf Management

- Reliable and proven chip flow management unit as standard.

- The chip flow unit discharges directly to the rear of the machine. A chip collection & 350L coolant tank are provided as standard.

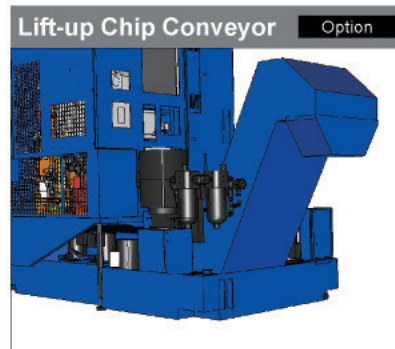
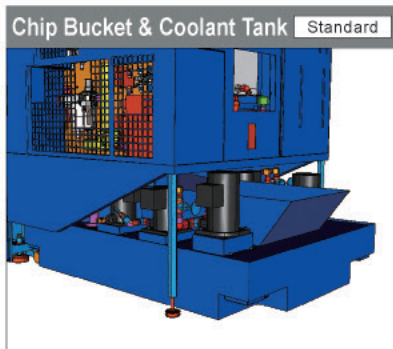
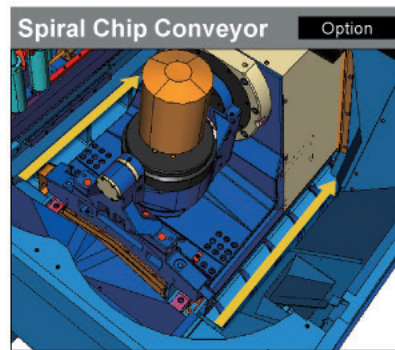
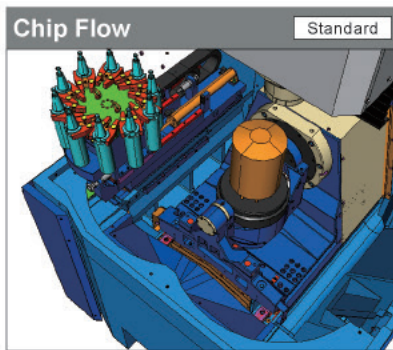

Installation Area

- The machine footprint is 15% smaller than that of our previous model **LX-0 5AX**, yet offers a larger workpiece envelope.

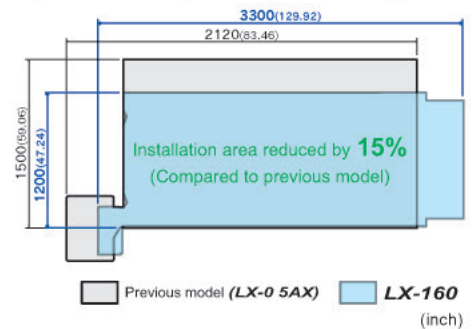

NC System



Matsuura L-Tech 30i

- Dynamic state of the art NC offering outstanding control, versatility and accuracy.

Intelligent Protection System



Ultra Safe Collision Protection



Safe Secure

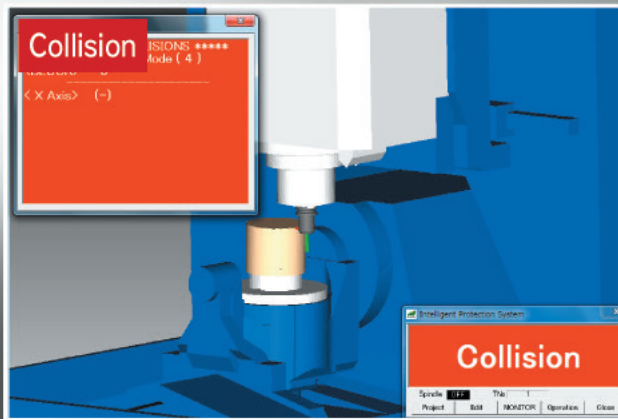

Intelligent Protection System OFF

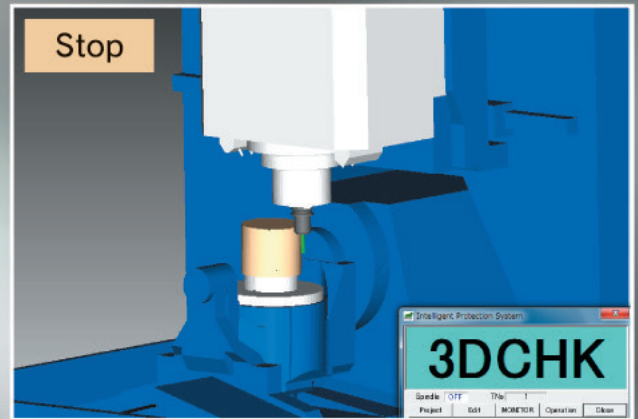

Intelligent Protection System ON

Manual / automatic operation supported
Simultaneous 5-axis machining supported

On-Line Link with PC

※ *Intelligent Protection System* simulates your programmed component alerting the user to any interference or collision before any actual machining.

※ Requires end user PC - consult Matsuura for full specifications.

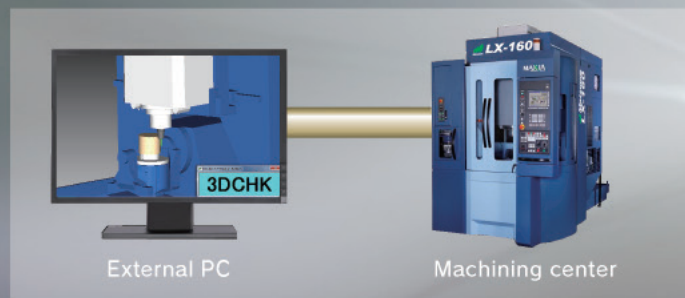

Collision Avoidance during Setup

Tool length compensation data is linked with the Intelligent Protection System.

As NC data changes, PC compensation data is automatically updated.

Collision Avoidance during Automatic Operation

Collision check can be activated during simulation. The collision check function renders the part in real time on screen.

Standard Accessories

Software	Machine model data
Communication cable	PC communication board

※ A high quality cable is provided to route from the NC to your PC Communication Board

Meister's knowledge, skills, and ideas combined

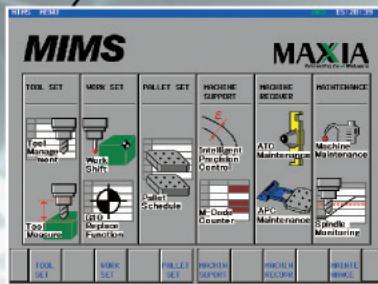

- **Environment**
 - Eco Meister**
 - Power Saving**
 - Power cut-off function
 - Energy-saving devices installed

- **Accuracy**
 - Thermal Meister**
 - Stable Accuracy**
 - Spindle thermal displacement compensation

- **Simple**
 - Operability Meister**
 - Fuss-Free Simple Operation**
 - Tool setup support
 - Workpiece setup support
 - Restart after machining stop

- **Secure**
 - Reliability Meister**
 - Machine Down Time Reduction**
 - Preventive maintenance support functions
 - Machine restoration support functions
 - Reliability Meister Plus Option**
 - Increased Security Provided**
 - Electronic manual
 - E-mailing function

※ Reliability Meister Plus requires a PC.
Consult Matsuura for more information.

Standard Machine Specifications

■ Movement and Range		
X-Axis Travel	mm (in.)	500 (19.69)
Y-Axis Travel	mm (in.)	250 (9.84)
Z-Axis Travel	mm (in.)	300 (11.81)
B-Axis Travel	deg	-125 – +125
C-Axis Travel	deg	360
From Table Surface To Spindle End	deg	30 – 330 (B-Axis 0 degree)
■ Table		
Working Surface	mm (in.)	Ø100 (Ø3.98)
Loading Capacity	kg (lb.)	20 (44.09)
Max. Work Size	mm (in.)	Ø160×H230 (Ø6.30×H9.06) * Bullet shape
Height from floor surface to table surface	mm (in.)	900 (35.43) (B-Axis 0 degree)
■ Spindle		
Spindle Speed Range	min ⁻¹	400 – 46,000
Spindle Taper		7 / 24 taper BT30 (Double contact type)
Spindle Motor Power	kW	7.5 / 15
Max. Spindle Motor Torque	N·m	8.68 (16,500min ⁻¹)
■ Feed Rate		
Rapid Traverse Rate (X/Y/Z)	mm/min(ipm)	90,000 (3543.31)
Rapid Traverse Rate (B)	min ⁻¹	100
Rapid Traverse Rate (C)	min ⁻¹	200
■ Automatic Tool Changer		
Type of Tool Shank		JIS B 6339 30T
Tool Storage Capacity	pcs.	10
Max. Tool Diameter	mm (in.)	Ø46 (Ø1.81)
Max. Tool Length	mm (in.)	150 (5.91)
Max. Tool Mass	kg (lb.)	1.5 (3.31)
■ Power Sources * Depending on options		
Power Capacity	kVA	43
■ NC System		
Control System		Matsuda L-Tech 30i

■ Standard Accessories	
01. Total Splash Guard	02. ATC Magazine Guard
03. ATC Auto Door	04. Spindle Oil Cooler
05. Auto Grease Supply Unit for X/Y/Z	06. Air Dryer
07. Synchronized Tapping	08. AD-TAP Function
09. IPC Function	10. Scale Feedback for the X/Y/Z/B/C-Axis
11. Coolant Unit	12. Chip Flow
13. Linear Motor Cooler	14. Spindle Overload Protection
15. 9 Sorts of M-code Counters	16. Work Light
17. Standard Mechanical Tool and Tool Box	18. Machine Color Paint
19. MIMS	20. Intelligent Protection System
21. Spindle Run Hour Meter	22. Leveling Pads and Bolts
23. Automatic Operation Run Hour Meter	
24. PC Tool for Memory Card Program Operation and Editing	

* 2 years spindle warranty

Outline (10-tool Magazine and NON-PC) Units: mm (in.)

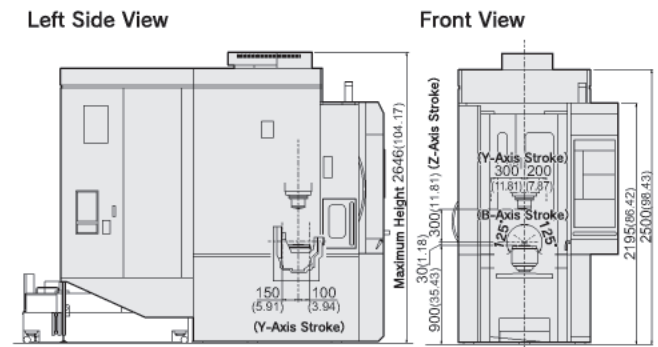

Floor Plan (10-tool Magazine and NON-PC) Units: mm (in.)

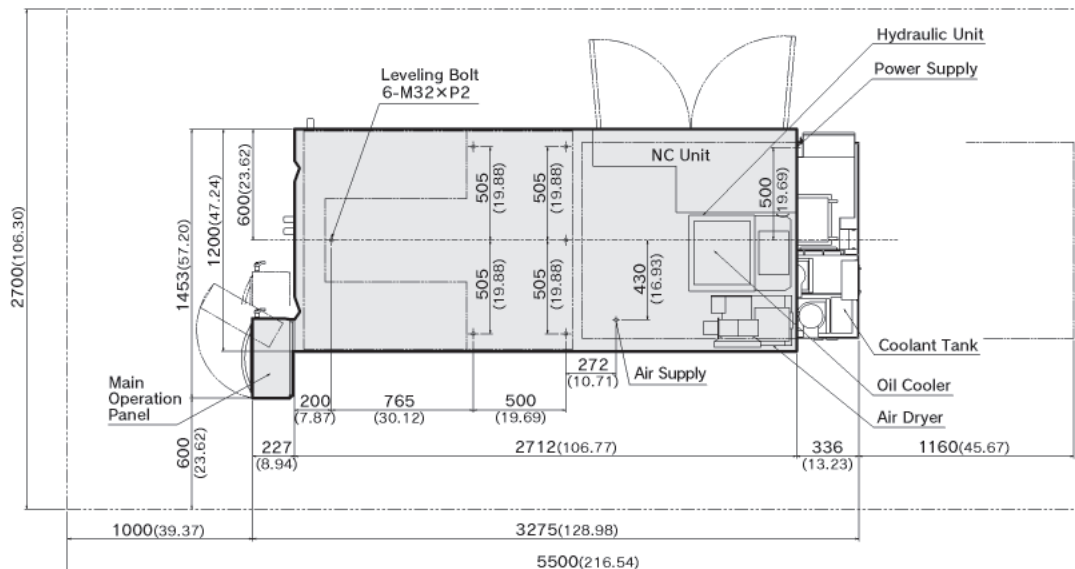

Equipment

○ : Standard ▲ : Option

■ Spindle	
46,000 min ⁻¹ (BT30 Oil-Air)	○
46,000 min ⁻¹ (HSK-E40 Oil-Air)	▲
■ ATC	
30 tools (#30, chain type)	▲
50 tools (#30, chain type)	▲
128 / 188 / 248 / 308 / 338 tools (base for 338 tools)	▲
■ High Accuracy Control	
Scale Feedback System X/Y/Z-Axis	○
■ APC	
PC2	▲
PC42	▲
PC91	▲
■ Coolant	
Coolant Tank	○
Vacuum Type Coolant-Thru-Spindle Type A	▲
Vacuum Type Coolant-Thru-Spindle Type B	▲
Vacuum Type Coolant-Thru-Spindle Type C 20BAR	▲
Vacuum Type Coolant-Thru-Spindle Type C 70BAR	▲
Coolant Flow Checker	▲
Mist Separator (without Fire Damper)	▲
Mist Separator (with Fire Damper)	▲
Coolant Temperature Controller (with 100L Tank, separate type, small)	▲
■ Automatic Measurement, Tool Breakage Detection	
Automatic Measurement / Automatic Alignment (Optical)	▲
Tool Breakage / Full Automatic Tool Length Measurement (Laser)	▲
Automatic Measurement (Optical) & Tool Breakage (Laser)	▲

■ Swarf Management	
Total Enclosure Guard	○
ATC Auto Door	○
Chip Flush System	○
Spiral Chip Conveyor	▲
Lift-up Conveyors (Scraper, Drum, Right and Left Spiral Conveyors)	▲
Air Blow For Chip / Swarf Removal	▲
Workpiece Cleaning Gun (Machine side)	▲
■ Operation / Maintenance	
AD-TAP Function	○
IPC Function	○
MIMS	○
Intelligent Protection System	
Auto Grease Supply to Feed Axis	○
Work Light	○
Spindle Run Hour Meter	○
8 Sets of Extra M Function	▲
Weekly Timer	▲
Rotary Wiper	▲
Optional Block Skip 2 - 9	▲
Reliability Meister Plus Type A	▲
Reliability Meister Plus Type B	▲
■ Safety Features	
Matsura Safety Specification	○
■ Optional Package	
High-Speed, High-Precision Package	▲
5-Axis Package	▲
High-Speed, High-Precision 5-Axis Package	▲
Value Package	▲
TRUE PATH	▲

Floor Plan (50-tool Magazine with PC2) Option Units: mm (in.)

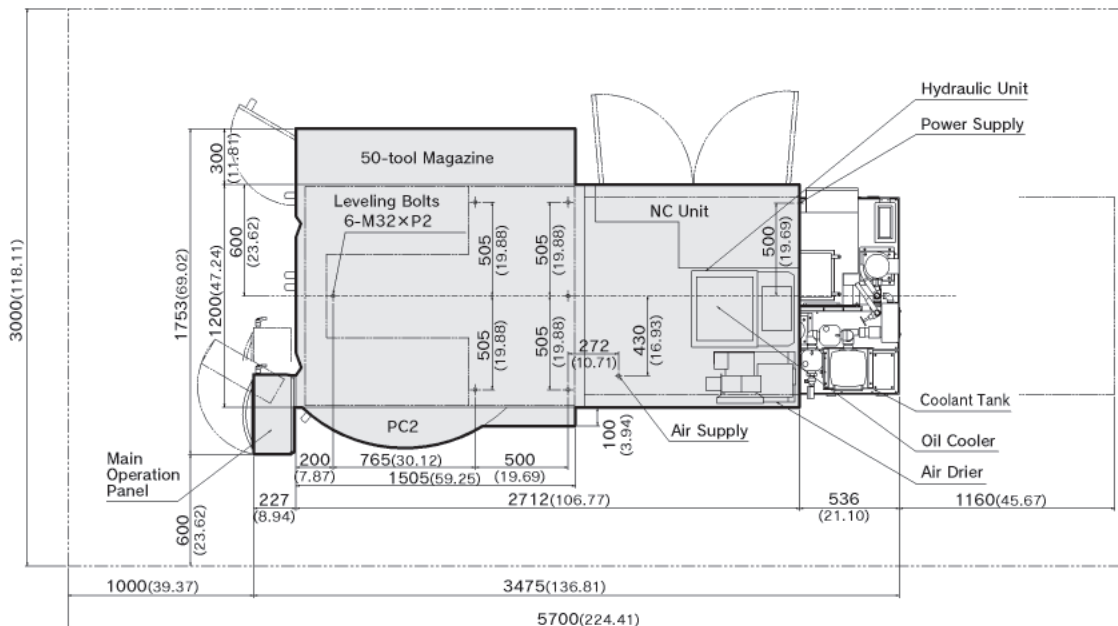



Matsuura

URL : <http://www.matsuura.co.jp/>

E-MAIL : webmaster@matsuura.co.jp

MATSUURA MACHINERY CORPORATION

1-1 Urushihara-cho Fukui City 910-8530, Japan
TEL : +81-776-56-8106 FAX : +81-776-56-8151

MATSUURA EUROPE GmbH

Berta-Cramer-Ring 21 D-65205 Wiesbaden-Delkenheim, Germany
TEL : +49-6122-7803-80 FAX : +49-6122-7803-33
URL : <http://www.matsuura.de/>
E-MAIL : info@matsuura.de

MATSUURA MACHINERY Ltd.

Gee Road, Whitwick Business Park, Coalville Leicestershire,
LE67 4NH, England
TEL : +44-1530-511-400 FAX : +44-1530-511-440
URL : <http://www.matsuura.co.uk/>
E-MAIL : sales@matsuura.co.uk
Facebook : www.facebook.com/pages/Matsuura-Machinery-Ltd/427006380682983

MATSUURA MACHINERY GmbH

Berta-Cramer-Ring 21 D-65205 Wiesbaden-Delkenheim, Germany
TEL : +49-6122-7803-0 FAX : +49-6122-7803-33
URL : <http://www.matsuura.de/>
E-MAIL : info@matsuura.de

ELLIOTT MATSUURA CANADA INC.

2120 Buckingham Road Oakville Ontario L6H 5X2, Canada
TEL : +1-905-829-2211 FAX : +1-905-829-5600
URL : <http://www.elliottmachinery.com/>
E-MAIL : sales@elliottmachinery.com

MATSUURA MACHINERY USA, INC.

325 Randolph Ave., St. Paul, MN 55102, U.S.A.
TEL : +1-651-289-9700
URL : <http://www.matsuurausa.com/>
E-MAIL : info@matsuurausa.com

-
- Product specifications and dimensions are subject to change without prior notice.
 - The photos may show optional accessories.

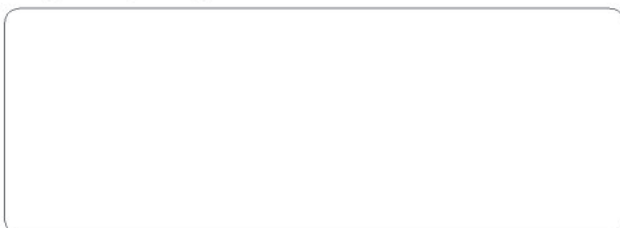

Products are subject to all applicable export control laws and regulations.

